



Your choice for inspired living

FURNITURE.

THERE IS MORE TO IT.

CHAIRS	4
TABLES	12
SEATERS	26

WHAT WE HAVE IN STORE FOR YOU

CABINETS	34
CARPETS	42
LIGHTING	48
HOME DECO	64

**CHERISH THE CHAIRS.
REAL TREASURES THEY ARE.**





Kubu chair

The beauty of rattan is not only in its natural colour, feel and looks, it is also in its characteristics. It grows for instance, in otherwise barren swamp areas and at an alarming rate of about 40 meters every year. We kept it uncoloured, and therefore not only at its prettiest but also at its environmental friendliest. We choose to work with the slightly thicker Kubu rattan for more style.

It's the simplicity that gives chair Kubu its undeniable style. The black powder coated frame is ultra thin and very good looking with its thin legs and stylish support bars.

Chair Kubu's seat is made from a thicker rattan, 6-8 mm, which you can style up with Dutchbones Sheepskin Shaun, for even more comfort and even more class.

- Kubu rattan shell
- Black powder coated iron frame
- Rubber feet
- Maximum weight load: 100 kg

ZUIVER-CODE	GTIN-CODE	ITEM NAME		
1100228	8718548020740	CHAIR KUBU		
PACKING	1 PCS/CTN			
QTY	CTN SIZE (CM)	CBM	NW (KG)	GW (KG)
1	53x51x51	0,138	6,09	7,98





Blackwood chair

The classic lounge chair has gone practical in our chair Blackwood. A comfortable addition to your seating area and packed with classic style and a nice salute to the fifties.

- Artificial leather upholstery (100% PU)
- Foam density 28
- Walnut veneered bentwood
- Black powdercoated steel frame
- Maximum weight load: 120 kg

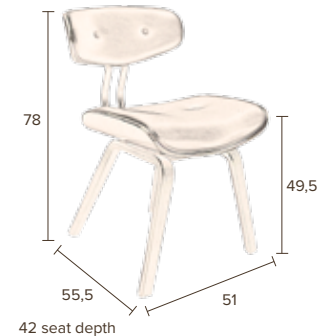

ZUIVER-CODE	GTIN-CODE	ITEM NAME			
1100240	8718548022133	CHAIR BLACKWOOD			
PACKING	1 PCS/CTN				
QTY	CTN SIZE (CM)	CBM	NW (KG)	GW (KG)	
1	51x55x43,5	0,12	7,8	9,5	



Scuola chair

The old-school, school chair gone chique. That's what happened to Dutchbone's Scuola chair, which has its origin in a small Italian workshop. The dark wood and black frame gives it an educated look. Yet we did not remove its low-tech qualities. Scuola is stackable and very capable of heavy duty usage.

When combined with table Scuola you have a match made in old - school, furniture heaven.

Back and seat in beech plywood, stained in walnut colour and finished with transparent varnish

Black powder coated steel frame

Stackable

Maximum weight load: 120 kg

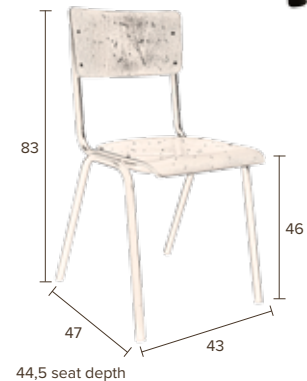

ZUIVER-CODE	GTIN-CODE	ITEM NAME			
1100239	8718548022126	CHAIR SCUOLA			
PACKING	4 PCS/CTN	ORDER QTY: 4 PCS			
QTY	CTN SIZE (CM)	CBM	NW (KG)	GW (KG)	
4	58x48,5x119	0,33	20 (4X5)	22	



Fez armchair

For Fez we were inspired by the sleek and simple lines you would often see in designs from the fifties. A chair without any pretense. Just being comfortable and stylish. Fez is beautifully upholstered in the perfect shade of vintage brown high quality PU-leather.

Artificial leather upholstery (100% PU)
 Plywood shell with polyether foam, density 25-30
 Black powder coated steel frame, plastic feet
 Birch armrest, walnut colour finish
 Maximum weight load: 120 kg

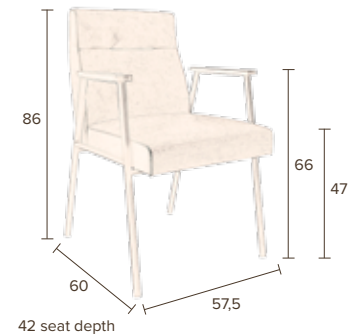

ZUIVER-CODE	GTIN-CODE	ITEM NAME			
1200111	8718548020993	ARMCHAIR FEZ VINTAGE BROWN			
PACKING	2 PCS/CTN	ORDER QTY: 2 PCS			
QTY	CTN SIZE (CM)	CBM	NW (KG)	GW (KG)	
2	63x77x74	0,359	22 (2X11)	24	



Juju chair

Simple beauty packed with style inspired by old colonial times. Her dark wooden legs, the fine fabric and her elegant style, that is what makes Juju the ultimate dining room chair.

100% polyester fabric
 Shell: metal tube inner frame + foam filling
 Ash wood legs, walnut colour finish
 Separate seat cushion with removable cover
 Maximum weight load: 100 kg

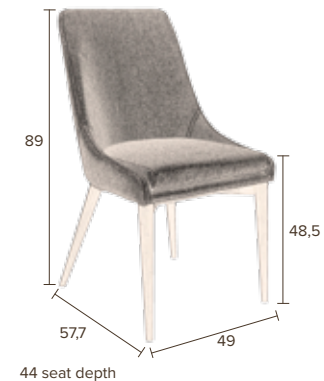

ZUIVER-CODE	GTIN-CODE	ITEM NAME			
1100232	8718548021181	CHAIR JUJU GREY			
1100233	8718548021204	CHAIR JUJU KHAKI			
PACKING	2 PCS/CTN	ORDER QTY: 2 PCS			
QTY	CTN SIZE (CM)	CBM	NW (KG)	GW (KG)	
2	80x75x61	0,366	15,8 (2X7,9)	19	



Stitched armchair

Stitched is a very comfortable cantilever framed chair, upholstered with high quality PU leather. The black frame is responsible for a comfortable little bounce. Stitched, got its name because of the detailed stitching we used in the upholstery. Stitched comes in two stylish colours.

Artificial leather (100% PU) upholstery & armrests
 Plywood shell with polyether foam, density 24-28
 Black powder coated steel frame, plastic gliders
 armrest
 Maximum weight load: 120 kg

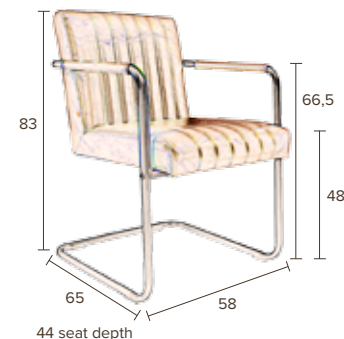

ZUIVER-CODE	GTIN-CODE	ITEM NAME			
1200117	8718548023222	ARMCHAIR STITCHED COGNAC			
1200118	8718548023239	ARMCHAIR STITCHED DARK GREY			
PACKING	2 PCS/CTN	ORDER QTY: 2 PCS			
QTY	CTN SIZE (CM)	CBM	NW (KG)	GW (KG)	
2	73x57x65	0,27	24 (2X12)	25,5	

TIME FOR TABLES.

DINNERTIME OR ANY TIME.





Kapal table

Shipwrecks, abandoned sheds and demolished houses. Those can easily be the previous lives of your Dutchbone table Kapal.

For table Kapal we found a carpenter in Central Java, Indonesia, who makes an effort in finding old, but still beautiful teak wood. During long walks on the beach, he gathers exotic and unique pieces of wood and turns them into beautiful products.

Our design team and this wood wizard developed table Kapal and we gave our reclaimed wooden table a pretty detail in the black iron legs.

4 cm solid recycled teak table top

Carbon steel legs, Ø 3-6 cm

Maximum weight load: 80 kg

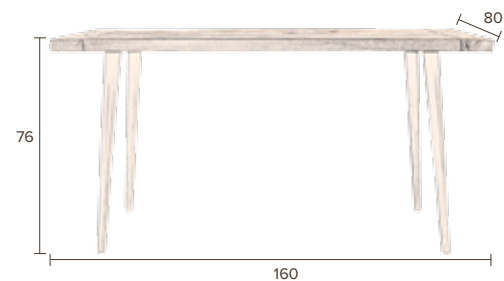

ZUIVER-CODE	GTIN-CODE	ITEM NAME		
2100052	8718548020320	TABLE KAPAL 160x80		
2100053	8718548020337	TABLE KAPAL 200x90		
PACKING	1 PCS/CTN			
SIZE	CTN SIZE (CM)	CBM	NW (KG)	GW (KG)
160X80	162x13x82	0,19	23	25
200x90	202x13x92	0,26	30	32





Scuola table

The combination of black steel and dark wood never gets old. We found the predecessor of this table in an Italian workshop. We tweaked it to our perfection. With tapered steel legs and a sleek table top Scuola came to life for us. We added Chair Scuola to this table, to complete the look.

2 cm birch plywood table top, stained in walnut colour and finished with transparent varnish
 Black powder coated steel frame
 Adjustable in height: 74 or 76 cm
 Maximum weight load: 150 kg

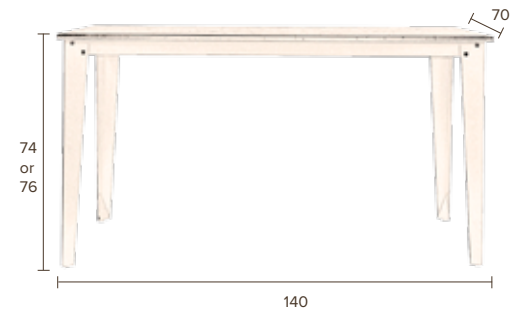
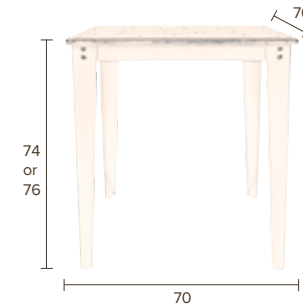

ZUIVER-CODE	GTIN-CODE	ITEM NAME		
2100059	8718548022102	TABLE SCUOLA 140x70		
2100060	8718548022119	TABLE SCUOLA 70x70		
PACKING	1 PCS/CTN			
SIZE	CTN SIZE (CM)	CBM	NW (KG)	GW (KG)
140x70	146x76x8	0,09	25	27
70x70	76x76x8	0,05	16	18



Juju table

Table Juju looks a bit like a table from the fifties, but look again and consider its size: 180x90 cm. No fifties table was ever made this big. Until now.

Table Juju has a smooth surface with sides in walnut veneer and is blessed with nicely tapered legs in an A-frame construction.

6 cm MDF hollow table top, finished in matte black
Sides with walnut veneer
Ash wood legs, walnut colour finish

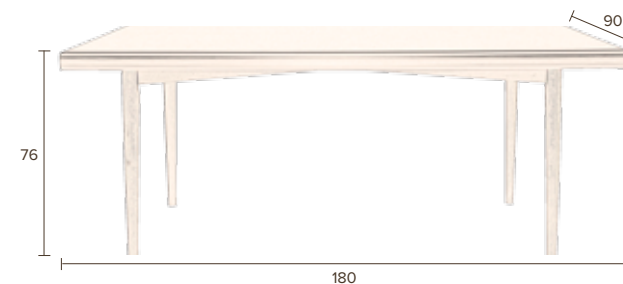

ZUIVER-CODE	GTIN-CODE	ITEM NAME			
2100054	8718548021228	TABLE JUJU 180x90			
PACKING	1 PCS/CTN				
QTY	CTN SIZE (CM)	CBM	NW (KG)	GW (KG)	
1	189x99x25,5	0,477	35	41	



Nuts table

Here's an idea: Simplicity can be more appealing than luxury. Our table Nuts is a good example of this theory. Familiar but never boring, with its dark walnut veneer and black steel base.

Table Nuts comes in a practical size, which makes it ideal for small rooms or forgotten corners.

18 mm MDF table top, walnut veneered and natural lacquered

Black powder coated steel tube frame (Ø 66 mm)

Adjustable rubber feet

Maximum weight load: 10-150 kg (edge-middle)



ZUIVER-CODE	GTIN-CODE	ITEM NAME		
2100055	8718548021471	TABLE NUTS ROUND 90'		
PACKING	1 PCS/CTN			
QTY	CTN SIZE (CM)	CBM	NW (KG)	GW (KG)
1	96x98x11	0,103	14	18



By Hand side table

For our block printed Dutchbone items we work with woodcarvers from the riverbanks in the Dhundbar region of India. Here craftsmen carve the wooden stamps needed to print fabrics.

We found the stamps themselves were already a work of art. Table By Hand is a tribute to their craftsmanship. Each table is hand carved.

Table Sheesham is the perfect match with By Hand.

Solid sheesham wood

35 mm table top, hand carved, PU-lacquered

Maximum weight load: 10 kg (M), 12 kg (L)

Dimensions:

M: 35x37 cm (Ø x H)

L: 40x45 cm (Ø x H)



ZUIVER-CODE	GTIN-CODE	ITEM NAME		
2300045	8718548020184	SIDE TABLE BY HAND M		
2300046	8718548020191	SIDE TABLE BY HAND L		
PACKING	1 PCS/CTN			
SIZE	CTN SIZE (CM)	CBM	NW (KG)	GW (KG)
M	41x39x11	0,018	2,5	4
L	49x44x11	0,024	3,4	4,5



Sheesham side table

For our block printed Dutchbone items we work with woodcarvers from the riverbanks in the Dhundbar region of India. There craftsmen carve the wooden stamps needed to print fabrics.

We found the stamps themselves were already a work of art. Table Sheesham is a tribute to their craftsmanship. Each table is hand carved.

Table By Hand is the perfect match with Sheesham.

Solid sheesham wood

35 mm table top, hand carved, PU-lacquered

Maximum weight load: 10 kg

Dimensions: 30x46 cm (Ø x H)



ZUIVER-CODE	GTIN-CODE	ITEM NAME		
2300047	8718548020207	SIDE TABLE SHEESHAM		
PACKING	1 PCS/CTN			
QTY	CTN SIZE (CM)	CBM	NW (KG)	GW (KG)
1	49x34x11	0,018	2,9	4



Kraton side table

In Indonesia we found the fundamentals of our side table Kraton. The top of the side table made out of several pieces of solid wood which are pressed together to form the surface. This remarkable technique ensures that no two Kraton's are alike and results in a rough and sturdy top. The skill of building a good interior is all about gathering notable furniture. And Kraton complies.

50 mm solid teak wood table top, chocolate lacquered
Black lacquered iron frame
Maximum weight load: 75 kg
Dimensions: 60x43 cm (Ø x H)



ZUIVER-CODE	GTIN-CODE	ITEM NAME		
2300044	8718548020177	SIDE TABLE KRATON CHOCOLATE		
PACKING	1 PCS/CTN			
QTY	CTN SIZE (CM)	CBM	NW (KG)	GW (KG)
1	65,5x65,5x49,5	0,21	15	16



Brok side table

Side table Brok looks like it was on safari with Karen Blixen in the movie 'Out of Africa'. Needless to say, Brok is perfect for all adventures and classic interiors. This side table is made out of metal and has a convenient diameter of seventy-eight centimeters.

Iron with vintage finish
15 mm table top on foldable frame
Maximum weight load: 20 kg
Dimensions: 78 x 40 cm (Ø x H)



ZUIVER-CODE	GTIN-CODE	ITEM NAME		
2300048	8718548020719	SIDE TABLE BROK		
PACKING	1 PCS/CTN			
QTY	CTN SIZE (CM)	CBM	NW (KG)	GW (KG)
1	80x20x80	0,13	6,5	7,5

Arabica coffee table

During our travels through Asia we noticed every small village has its coffee 'corner', where people gather to drink a strong brewed coffee, sitting at small tables. Tables like our coffee table Arabica. We gave ours a twist though. Quite literally. In the form of the one turned wooden leg. Arabica comes in three sizes and heights, which perfectly nest together to one big overlapping coffee table.

9 mm MDF table top and plywood border
Walnut veneered and natural lacquered
Rubber wood legs, walnut colour finish
Maximum weight load: 10 kg

Dimensions:

S: 40x45 cm (Ø x H)

L: 58,5x40 cm (Ø x H)

XL: 78x35 cm (Ø x H)



ZUIVER-CODE	GTIN-CODE	ITEM NAME		
2200003	8718548019676	COFFEE TABLE ARABICA S		
2200004	8718548019683	COFFEE TABLE ARABICA L		
2200005	8718548019690	COFFEE TABLE ARABICA XL		
PACKING	1 PCS/CTN			
SIZE	CTN SIZE (CM)	CBM	NW (KG)	GW (KG)
S	48x43,5x9,4	0,02	1,9	2,4
L	63x64,5x9	0,037	4,2	4,8
XL	83x81x9	0,061	5,2	6,5



Triple side table

Burned coffee beans, curry masala, ground aniseed and dried peppercorns. Those are only a few of the colours every traveler to the East will recognize. For Triple Table we were inspired by those colours. This clever side table looks like three tables combined in to one, but it is just one.

12 mm MDF table top in a 3 colour-combination (orange, green and brown)
 Solid rubber wood legs, same colour finish
 Maximum weight load: 10 kg
 Dimensions: 50x50X40 cm (WxDxH)



ZUIVER-CODE	GTIN-CODE	ITEM NAME		
2300042	8718548019706	SIDE TABLE TRIPLE		
PACKING	1 PCS/CTN			
QTY	CTN SIZE (CM)	CBM	NW (KG)	GW (KG)
1	62,5x53x6	0,018	3,25	3,95

**TAKE A SEAT.
A COMFORTABLE ONE.**



Chester sofa

At Dutchbone we are often inspired by classic designs from the early twentieth century. Like the Chesterfield sofa, which actually originates from the eighteenth century. We have decided that this classic design is back in style, yet again. Of course our version comes with a 21st century twist. We skipped the leather and used a nice vintage cotton for a surprising effect. Sofa Chester is smaller than most of its ancient predecessors and therefore suitable for any interior.

100% cotton fabric, colour fastness 3-4
 Filling: polyether foam, density 30-35
 Solid oak legs, dark brown finish
 Maximum weight load: 600 kg

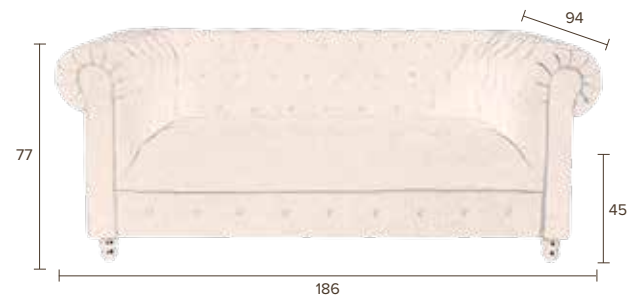

ZUIVER-CODE	GTIN-CODE	ITEM NAME		
3200028	8718548020795	SOFA CHESTER VINTAGE FOREST 13		
3200029	8718548020801	SOFA CHESTER VINTAGE DESERT 14		
PACKING	1 PCS/CTN			
QTY	CTN SIZE (CM)	CBM	NW (KG)	GW (KG)
1	194x101x82	1,607	39	41



Smoker lounge chair

Lounge chair Smoker brings back memories of old timer, family cars. The bucket seats from these old-timers were in a way designed for a proper lounge area.

In honor of these old-timer cars we introduce Smoker. Smoker comes in three vintage colours.

100% polyester fabric with mixed fabric piping
(57% viscose, 28% linen, 15% cotton)
> 35.000 Martindale

Filling: polyurethane foam

Foam density seat 32, back 25

Solid oak legs, dark brown oil finish

Maximum weight load: 120 kg



ZUIVER-CODE	GTIN-CODE	ITEM NAME			
3100024	8718548019867	LOUNGE CHAIR SMOKER DARK GREY			
3100025	8718548019874	LOUNGE CHAIR SMOKER RED			
3100026	8718548019881	LOUNGE CHAIR SMOKER BEIGE			
PACKING	1 PCS/CTN				
QTY	CTN SIZE (CM)	CBM	NW (KG)	GW (KG)	
1	76x63x82	0,392	9,5	12	



Bar lounge chair

Suddenly we saw it slowly coming up. Everywhere we travelled: Liberally upholstered easy chairs. Lots of cushioning and lots of comfortable fabric. Chair Bar is our version to that spotted trend. Our design team loves the seventies feel Bar has.

- 100% polyester fabric
- Plywood shell with PU-foam, density 25-30
- Black steel swivel frame
- Maximum weight load: 150 kg

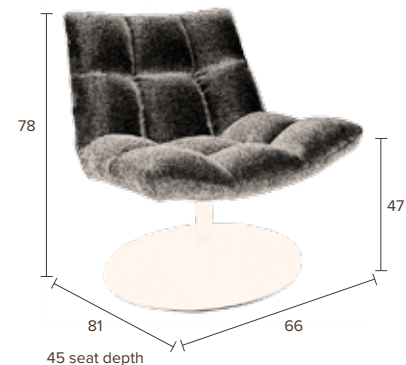

ZUIVER-CODE	GTIN-CODE	ITEM NAME			
3100029	8718548021457	LOUNGE CHAIR BAR LIGHT GREY			
3100030	8718548021464	LOUNGE CHAIR BAR DARK GREY			
PACKING	1 PCS/CTN				
QTY	CTN SIZE (CM)	CBM	NW (KG)	GW (KG)	
1	90x41x69	0,255	17	20	



Don lounge chair

Lounge chair Don is for men with barbered beards and old school tattoos. But also for anyone with a stylish interior which is in need of a good, swivel footed easy chair. Don is a dandy lounge chair and a real stand-alone. Don comes in two colours: black and cognac.

Upholstery in leatherlook (100% PU)

Filling: polyester foam

Foam density seat 30, back 25

Black powdercoated steel swivel frame

Maximum weight load: 150 kg

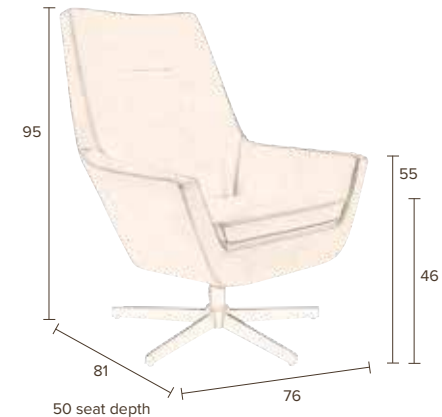

ZUIVER-CODE	GTIN-CODE	ITEM NAME			
3100027	8718548020153	LOUNGE CHAIR DON BLACK			
3100028	8718548020160	LOUNGE CHAIR DON COGNAC			
PACKING	1 PCS/CTN				
QTY	CTN SIZE (CM)	CBM	NW (KG)	GW (KG)	
1	L-shaped box: 74 (31/43)x77x79(43/46)	0,31	12,5	15,5	



Kubu armchair

The beauty of rattan is not only in its natural colour, feel and looks, it is also in its characteristics. It grows for instance, in otherwise barren swamp areas and at an alarming rate of about 40 meters every year. We kept it uncoloured, and therefore not only at its prettiest but also at its environmental friendliest. We choose to work with the slightly thicker Kubu rattan for more style.

With its considered detailing and sensitive use of rattan, armchair Kubu is a perfect blend of boldness and elegance. The thin black powder coated frame and wooden armrests result in both a stylish and strong armchair. Armchair Kubu's seat is made out of a thicker rattan, 6-8 mm, which you can style up with Dutchbones sheepskin Shaun for even more comfort and even more style.

Kubu rattan shell

Black powder coated iron frame with rubber feet

Solid teak armrests

Maximum weight load: 100 kg

ZUIVER-CODE	GTIN-CODE	ITEM NAME			
1200115	8718548020764	ARMCHAIR KUBU			
PACKING	1 PCS/CTN				
QTY	CTN SIZE (CM)	CBM	NW (KG)	GW (KG)	
1	80x78x89	0,555	10,36	15,13	

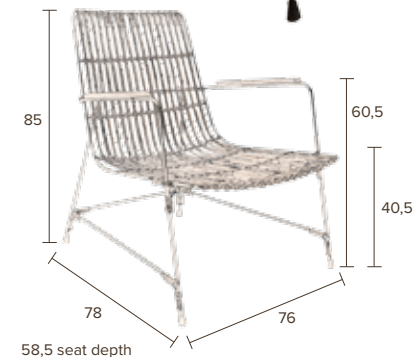

Kubu Round chair

The beauty of rattan is not only in its natural colour, feel and looks, it is also in its characteristics. It grows for instance, in otherwise barren swamp areas and at an alarming rate of about 40 meters every year. We kept it uncoloured, and therefore not only at its prettiest but also at its environmental friendliest. We choose to work with the slightly thicker Kubu rattan for more style.

Chair Kubu Round is a sculptural armchair, made out of sturdy natural Kubu rattan and an elegant, thin black powder coated frame. Kubu Round is the perfect combination of an elegant curve with a compact and simple form.

Kubu Round can be styled up with Dutchbones sheepskin Shaun for even more comfort and even more class.

Kubu rattan shell
Black powder coated iron frame
Rubber feet
Maximum weight load: 100 kg

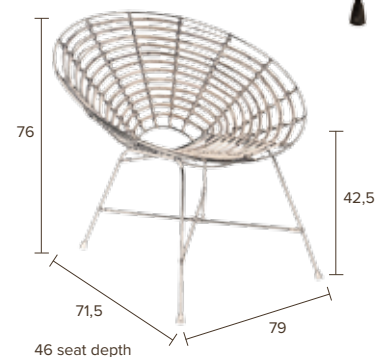

ZUIVER-CODE	GTIN-CODE	ITEM NAME			
1100229	8718548020757	CHAIR KUBU ROUND			
PACKING	1 PCS/CTN				
QTY	CTN SIZE (CM)	CBM	NW (KG)	GW (KG)	
1	83x70x50	0,291	7,96	11,6	



**DO NOT MESS THINGS UP.
GET ORGANIZED.**





Juju sideboard

For years now we have had a family heirloom standing at our headquarters. It was a signature cabinet originating from the house of one of our grandmothers. It was over 40 years old and suddenly completely in style again. So much so, it inspired us to include a similar design in our collection: Cabinet Juju a.k.a Grandma's cabinet.

MDF body and inside, finished in matte black
Walnut veneered doors & drawer fronts
Ash wood legs, walnut colour finish

Sideboard low:

2 doors and shelves, 1 drawer, 1 flap compartment with cable opening at the back

Sideboard high:

3 doors and 3 shelves

ZUIVER-CODE	GTIN-CODE	ITEM NAME			
4300003	8718548021167	SIDEBOARD JUJU LOW			
4300004	8718548021174	SIDEBOARD JUJU HIGH			
PACKING	1 PCS/CTN				
SIZE	CTN SIZE (CM)	CBM	NW (KG)	GW (KG)	
LOW	159x49x22	0,171	37	40	
HIGH	161,5x50,5x22	0,1719	38	41,3	

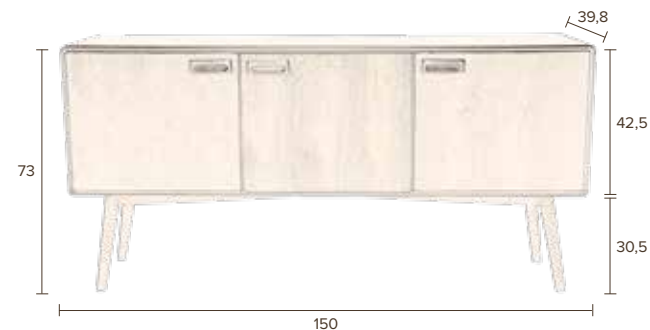
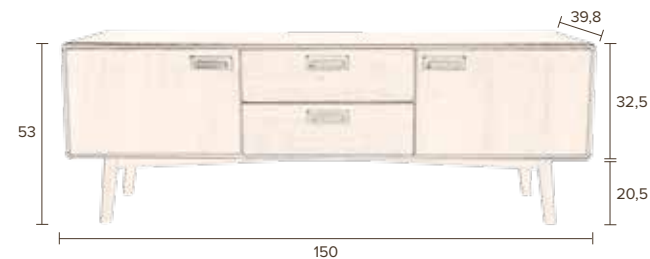





Sol cabinet and sideboard

Papers, papers and even more papers. Our Cabinet Sol will cherish them all for you. This pretty vintage-looking cabinet is inspired by old school sideboards. Because one can never have too many drawers, our translation of this classic comes in three sizes: Tall, smaller and a fabulous sideboard.

MDF body in vintage iron look, n/c lacquered
 Solid pine wood drawers in vintage finish
 Metal handles & label holders
 Stoved iron legs

Number of drawers:

Sol M: 2 large (double) drawers + 1 small one at the top
 Sol L: 3 large (double) drawers + 1 small one at the top
 Sol sideboard: 3 large (double) drawers, 3 small drawers + 3 open drawers at the top

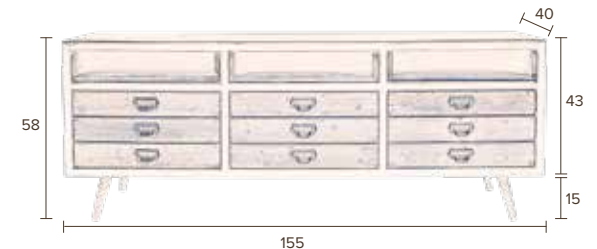
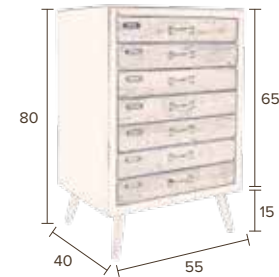
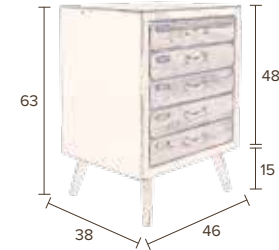

ZUIVER-CODE	GTIN-CODE	ITEM NAME			
4100007	8718548020832	CABINET SOL L			
4100008	8718548020849	CABINET SOL M			
4300001	8718548020856	SIDEBOARD SOL			
PACKING	1 PCS/CTN				
SIZE	CTN SIZE (CM)	CBM	NW (KG)	GW (KG)	
L	60x45x71	0,192	17	19	
M	51x43x54	0,118	12	14	
SIDEBOARD	160x45x49	0,353	33	35	





Fuz cabinet and sideboard

Vintage yet modern, old school but brand new. Our Fuz cabinet and sideboard have it all. These dark wooden pieces with wood carved panels, are more than average storage units. They are potential future heirlooms!

Solid pinewood in vintage finish
 Carved floral pattern
 Cabinet: 2 large drawers, 2 smaller drawers and 2 doors with magnetic closure
 Sideboard: 4 drawers and 2 doors with magnetic closure

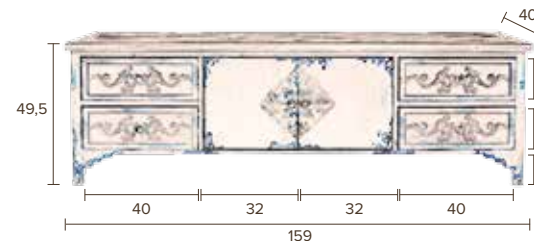
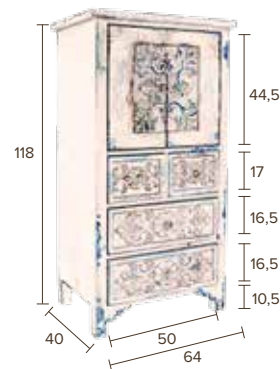

ZUIVER-CODE	GTIN-CODE	ITEM NAME			
4100015	8718548020818	CABINET FUZ			
4300002	8718548020825	SIDEBOARD FUZ			
PACKING	1 PCS/CTN				
SIZE	CTN SIZE (CM)	CBM	NW (KG)	GW (KG)	
CABINET	69x49x127,5	0,431	26	28	
SIDEBOARD	168x49x59	0,486	23	25	



Brooke cabinet

Our small cabinet Brooke is as versatile as can be. This smart and pretty locker is made of metal. It has two compartments and stands most conveniently on wheels. Use it under your desk for storing papers or next to your bed as a nightstand, even in your kitchen as the perfect extra cupboard for spices and a respectable oil and vinegar collection.

Iron with vintage finish
 2 doors with magnetic closure
 On wheels (6 cm castors)



ZUIVER-CODE	GTIN-CODE	ITEM NAME		
4100016	8718548022096	CABINET BROOKE		
PACKING	1 PCS/CTN			
QTY	CTN SIZE (CM)	CBM	NW (KG)	GW (KG)
1	50,5x41,5x80	0,17	11,5	13



**WHENEVER YOU NEED COMFORT,
CARPETS ARE THERE FOR YOU.**



Indian Block carpet

Block printing was traditionally used on cotton cloth. But techniques and fabrics developed and nowadays it can also be applied to thicker, sturdier fabric. Like our fabulous rug Indian Block carpet. The stamp was made by an artisan carpenter who hand carved the wooden blocks. Thereafter the print was hand stamped on the rugs. Carpet Indian Block comes in two colours; A vibrant yellow and a distinguished grey, matching colours that go very well with our other block printed items.

100% cotton, block printed by hand
Dimensions: 120x180 cm (WxL)



ZUIVER-CODE	GTIN-CODE	ITEM NAME		
6000028	8718548019973	CARPET INDIAN BLOCK 120X180 YELLOW		
6000029	8718548019980	CARPET INDIAN BLOCK 120X180 GREY		
PACKING	4 PCS/CTN	ORDER QTY: 4 PCS		
QTY	CTN SIZE (CM)	CBM	NW (KG)	GW (KG)
4	65x50x12	0,039	8,4 (4X2,1)	9,4



Shisha carpet

Carpet Shisha is a typical new classic. We took a traditional pattern and used modern techniques to make a low-pile and surprisingly soft carpet. This rug is available in three shades. The two lightest shades have a chic, faded design. Shisha has a fringe-edge for a classy finishing touch.

Machine woven carpet with decorative fringes
 Pile: 90% heat-set polypropylene Decolan and 10% viscose, for a wool-like appearance with a silky shine
 Back finished with jute
 3 dimensions (fringes included):

- 67x245 cm (WxL)
- 160x235 cm (WxL)
- 200x295 cm (WxL)



ZUIVER-CODE	GTIN-CODE	ITEM NAME		
6000013	8718548019089	CARPET SHISHA 67x245 DESERT		
6000014	8718548019096	CARPET SHISHA 160x235 DESERT		
6000015	8718548019102	CARPET SHISHA 200x295 DESERT		
6000016	8718548019119	CARPET SHISHA 67x245 CAVE		
6000017	8718548019126	CARPET SHISHA 160x235 CAVE		
6000018	8718548019133	CARPET SHISHA 200x295 CAVE		
6000019	8718548019140	CARPET SHISHA 67x245 FOREST		
6000020	8718548019157	CARPET SHISHA 160x235 FOREST		
6000021	8718548019164	CARPET SHISHA 200x295 FOREST		
PACKING	1 PCS/CTN			
SIZE	PACKING SIZE (CM)	CBM	NW (KG)	GW (KG)
67x245	82x20 (L x Ø)	0,02	4,583	4,72
160x235	175x23 (L x Ø)	0,05	10,488	10,8
200x295	220x25 (L x Ø)	0,09	16,53	16,86



Rugged carpet

Our carpet Rugged is the perfect translation from old to new. Although this vintage rug resembles a classic carpet, it is very contemporary. Made of modern materials with modern techniques. This trendy woven carpet seems a sanded Persian rug, but is very soft and therefore more comfortable.

Machine woven carpet

Composition: 66% viscose, 25% cotton, 9% polyester

2 dimensions:

- 170x240 cm (WxL)
- 200x300 cm (WxL)

ZUIVER-CODE	GTIN-CODE	ITEM NAME		
6000022	8718548019195	CARPET RUGGED 170x240 DARK		
6000023	8718548019201	CARPET RUGGED 200x300 DARK		
6000024	8718548019218	CARPET RUGGED 170x240 LIGHT		
6000025	8718548019225	CARPET RUGGED 200x300 LIGHT		
6000026	8718548019232	CARPET RUGGED 170x240 OCEAN		
6000027	8718548019249	CARPET RUGGED 200x300 OCEAN		
PACKING	1 PCS/PLASTIC			
SIZE	PACKING SIZE (CM)	CBM	NW (KG)	GW (KG)
170x240	180x10 (LxØ)	0,018	5,3	5,7
200x300	205x15 (LxØ)	0,047	7,8	8,2





LIGHTEN UP!
PLENTY OF CHOICES.





Beads pendant lamp

Down to earth wooden beads and clear sockets for the light bulbs. That is what defines Dutchbones Beads chandelier.

The height of the chandelier is adjustable. When you adjust the height it makes the loop of the bead chain bigger (more dramatic) or smaller (more elegant). That way the look of chandelier Beads can be modified to light up any room.

Black iron wired shade with 7 lampholders and wooden beads chains

Black lacquered iron canopy, 15x4 cm (Ø x H)

Black pvc cable

Adjustable in height

Light source: E27, max. 13 watt CFL, max. 40 watt regular bulb

Wire length: 155 cm

Dimensions: 55x110 cm (Ø x H)



ZUIVER-CODE	GTIN-CODE	ITEM NAME		
5300052	8718548019812	PENDANT LAMP BEADS		
PACKING	1 PCS/CTN			
QTY	CTN SIZE (CM)	CBM	NW (KG)	GW (KG)
1	82x82x17	0,11	3,8	5,8
ZUIVER-CODE	GTIN-CODE	ITEM NAME		
7900005	8718548020115	BULB BEADS 40W		
PACKING	1 PCS/CTN, 30 PCS/MASTERCTN			
QTY	CTN SIZE (CM)	CBM	NW (KG)	GW (KG)
1	6,5x6,5x14,5	0,0006	0,03	0,045
30	35x20x33	0,02	0,9	2,6

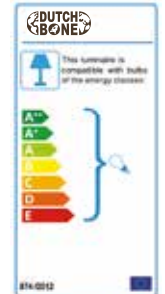

Kubu pendant lamp

The beauty of rattan is not only in its natural colour, feel and looks, it is also in its characteristics. It grows for instance, in otherwise barren swamp areas and at an alarming rate of about 40 meters every year. We kept it uncoloured, and therefore not only at its prettiest but also at its environmental friendliest. We choose to work with the slightly thicker Kubu rattan for more style.

They say that simplicity is the outward sign and symbol of depth of thought. Our pendant lamp Kubu proves that saying. Made out of simple curved Kubu rattan this pendant looks simple, but once lit it'll throw a stylish interaction of shadows and light on its surroundings. Imagine more than one pendant lamp Kubu in different heights and in a group...

Kubu rattan shade, iron construction inside
Stainless steel canopy, 9,5x2 cm (Ø x H)
Black pvc cable, adjustable in height
Light source: E27, max. 13 watt CFL
Wire length: 155 cm
Dimensions shade: 45x49 cm (Ø x H)
Total dimensions: 45x200 cm (Ø x H)



ZUIVER-CODE	GTIN-CODE	ITEM NAME		
5300058	8718548020870	PENDANT LAMP KUBU		
PACKING	1 PCS/CTN			
QTY	CTN SIZE (CM)	CBM	NW (KG)	GW (KG)
1	49x49x51	0,122	2,76	4,17

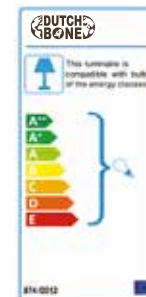



Bond pendant lamp

When one travels around the world, shopping for inspiration for new materials, styles and products, ideas for unconventional combinations can suddenly pop up. That is what happened with pendant lamp Bond. Our design team decided to combine light and wood veneer. Ash wood turned out to give the best results in bending and emitted light colour. Pendant lamp Bond consist of interlocking strips of veneer, which gives it its textured surface. Bond comes in two forms; round and oval.

Ash wood veneer strokes shade
 ABS plastic canopy, 11x8 cm (Ø x H)
 Black textured cable, adjustable in height
 Light source: E27, max. 13 watt CFL
 Visible wire length: 120 cm (round), 130 cm (oval)
 Dimensions shade Round: 40x37 cm (Ø x H)
 Total dimensions Round: 40x166 cm (Ø x H)
 Dimensions shade Oval: 50x18,5 cm (Ø x H)
 Total dimensions Oval: 50x156,5 cm (Ø x H)



ZUIVER-CODE	GTIN-CODE	ITEM NAME		
5300050	8718548019799	PENDANT LAMP BOND ROUND		
5300051	8718548019805	PENDANT LAMP BOND OVAL		
PACKING	1 PCS/CTN			
SIZE	CTN SIZE (CM)	CBM	NW (KG)	GW (KG)
ROUND	42x42x42	0,074	0,65	2,5
OVAL	52x52x21	0,057	0,5	2,1

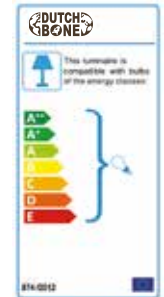

Cradle pendant lamp

Our designers travel to international design fairs several times a year. In all these design laden cities, concrete was the up and coming material. We combined concrete with solid wood for an extra contemporary Dutchbone touch. Cradle comes in two different shapes, both elegant versions.

Concrete shade with solid ashwood top
 Black lacquered iron canopy, 12x2,5 cm (Ø x H)
 Black textured cable, adjustable in height
 Light source: E27, max. 13 watt CFL
 Visible wire length: ca. 131 cm
 Dimensions shade Bottle: 18,5x34,5 cm (Ø x H)
 Total dimensions Bottle: 18,5x168 cm (Ø x H)
 Dimensions shade Carafe: 21x30,5 cm (Ø x H)
 Total dimensions Carafe: 21x164 cm (Ø x H)

ZUIVER-CODE	GTIN-CODE	ITEM NAME		
5300048	8718548019775	PENDANT LAMP CRADLE BOTTLE		
5300049	8718548019782	PENDANT LAMP CRADLE CARAFE		
PACKING	1 PCS/CTN			
SIZE	CTN SIZE (CM)	CBM	NW (KG)	GW (KG)
BOTTLE	23x23x40,5	0,02	3	3,35
CARAFE	25x25x36	0,02	2,8	3,2

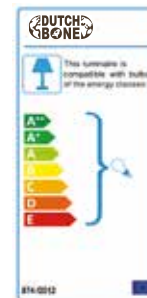



Coco pendant lamp

Pendant Lamp Coco comes in three very different versions, but all clearly bear the same family genes. Which shows in the form of the dome and the pretty mango wooden tip.

Combinations of our three different Coco pendant lamps are therefore very well possible. Though Coco is very pretty on its own as well.

Iron metal shade with solid mango wood top
Iron canopy, 10x5 cm (Ø x H)

Copper: copper plated shade & canopy, black top

Black: glossy black shade & canopy, whitewash top

Ivory: pearled ivory shade & canopy, whitewash top

Black & white textured PVC cable, adjustable in height

Light source: E27, max. 11 watt CFL

Wire length: 77 cm

Dimensions shade (without top): 34x14 cm (Ø x H)

Total dimensions: 34x110 cm (Ø x H)

ZUIVER-CODE	GTIN-CODE	ITEM NAME			
5300055	8718548020122	PENDANT LAMP COCO COPPER			
5300056	8718548020139	PENDANT LAMP COCO GLOSSY BLACK			
5300057	8718548020146	PENDANT LAMP COCO IVORY			
PACKING	1 PCS/CTN				
QTY	CTN SIZE (CM)	CBM	NW (KG)	GW (KG)	
1	36x36x21	0,0272	2,6	3,25	



Coco Copper

Our Coco Copper has a very unique finish with its flamed copper, coloured dome. We torched the material to give Coco Copper its special „colourful” finish. With its combination of two natural materials, stained mango wood and copper, this beauty is definitely an eye catcher.

Coco Glossy Black

Coco Glossy Black has a distinguished look, due to the combination of whitewashed mango wood and high gloss metal. A treasure we found in India.

Coco Ivory

Coco Ivory is like her sisters blessed with a combination of beautiful materials. The mango wooden tip has a whitewash finish, which is a perfect match with the pearled ivory shine of the metal dome.

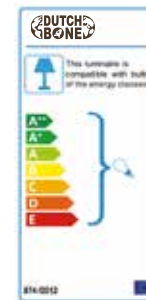

Kecil pendant lamp

Pendant lamp Kecil is an exquisite perforated dark metal bulb. When switched on, the light shines through the carefully made, open pattern.

This pattern creates a spectacular light effect on ceilings and walls.

Kecil's wire is wrapped with rope and its inside is orange for an even warmer light effect.

Tip: make a combination of several Kecils for a stunning look.

Hand embossed iron shade, powder coated

Greyish black outside, orange inside

Black powder coated iron canopy, 10x5 cm (Ø x H)

Black PVC cable, covered in natural jute

Light source: E14, max. 5 watt CFL

Wire length: 100 cm

Dimensions shade: 15x14 cm (Ø x H)

Total dimensions: 15x114 cm (Ø x H)

ZUIVER-CODE	GTIN-CODE	ITEM NAME		
5300054	8718548019850	PENDANT LAMP KECIL		
PACKING	4 PCS/CTN	ORDER QTY: 4 PCS		
QTY	CTN SIZE (CM)	CBM	NW (KG)	GW (KG)
1	17,5x17,5x27	0,008	0,7	0,95
4	38x38x30	0,043	2,8	5,5

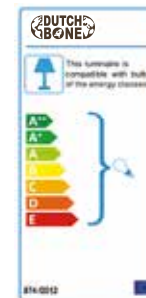

Besar pendant lamp

Pendant Lamp Besar looks like an old barrel which we transformed into a sturdy pendant lamp. The used metal and worn look contributes to its rough appearance. For an extra touch of style this huge lamp is suspended from a wire wrapped with rope.

Handmade iron shade & canopy, 10x6,5 cm (Ø x H)
 Finished in rust patina lacquer
 Black PVC cable, covered in natural jute
 Light source: E27, max. 15 watt CFL
 Wire length: 100 cm
 Dimensions shade: 50x33 cm (Ø x H)
 Total dimensions: 50x133 cm (Ø x H)

ZUIVER-CODE	GTIN-CODE	ITEM NAME		
5300053	8718548019843	PENDANT LAMP BESAR		
PACKING	1 PCS/CTN			
QTY	CTN SIZE (CM)	CBM	NW (KG)	GW (KG)
1	56x56x46	0,144	4,225	8,06

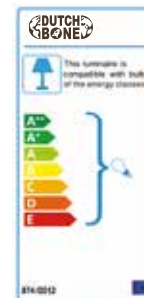



Cooper pendant lamp

Our sparkling Cooper pendant lamp is created out of hundreds of small 'flakes' of copper, which are burned with a torch for a flamed look.

The copper flakes are all placed by hand to give the lampshade its unique shape. The light bounces on and off the copper creating a dramatic effect. The different sizes and shapes of Cooper allows them to be mounted in rows or even in clusters. Above a dinner table, a kitchen counter, in a hallway or any other place that can use a touch of chic copper sparkling.

Hand made iron shade, copper plated
 Copper plated iron canopy, 12x2,5 cm (Ø x H)
 Black textured PVC cable, adjustable in height
 Light source: E27, max. 13 watt CFL

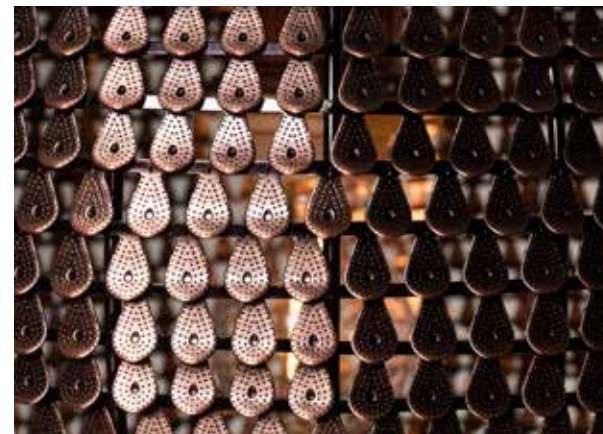

ZUIVER-CODE	GTIN-CODE	ITEM NAME			
5300043	8718548019720	PENDANT LAMP COOPER '40			
5300044	8718548019737	PENDANT LAMP COOPER '30			
PACKING	1 PCS/CTN				
SIZE	CTN SIZE (CM)	CBM	NW (KG)	GW (KG)	
'40	44x44x40	0,077	2,1	3,5	
'30	33x33x35	0,038	1,3	2,1	

ZUIVER-CODE	GTIN-CODE	ITEM NAME			
5300045	8718548019744	PENDANT LAMP COOPER LARGE			
5300046	8718548019751	PENDANT LAMP COOPER MEDIUM			
PACKING	1 PCS/CTN				
SIZE	CTN SIZE (CM)	CBM	NW (KG)	GW (KG)	
LARGE	39x39x31	0,047	1,5	2,6	
MEDIUM	34x34x30	0,03	1,3	2,35	



Cooper '40:
Wire length: 120 cm
Dimensions shade: 40x38 cm (Ø x H)
Total dimensions: 40x160 cm (Ø x H)

Cooper '30:
Wire length: 128,5 cm
Dimensions shade: 30x29 cm (Ø x H)
Total dimensions: 30x160 cm (Ø x H)



Cooper Large:
Wire length: 119 cm
Dimensions shade: 35x28,5 cm (Ø x H)
Total dimensions: 35x150 cm (Ø x H)

Cooper Medium:
Wire length: 121,5 cm
Dimensions shade: 35x26 cm (Ø x H)
Total dimensions: 30x150 cm (Ø x H)

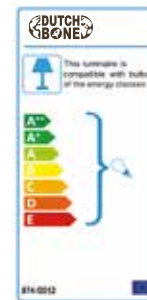

Batched Copper pendant lamp

The barn lamp is a classic design that we wanted to provide a new perspective on. Our interpretation of this design classic comes in an unexpected combination of batched copper and the common shape of the barn lamp. The result is our pendant lamp Batched Copper, with a modern and warm appearance.

iron shade, copper plated and hammered
 Copper plated iron canopy, 12x2,5 cm (Ø x H)
 Black textured PVC cable, adjustable in height
 Light source: E27, max. 13 watt CFL
 Wire length: 132,5 cm
 Dimensions shade: 45,5x30 cm (Ø x H)
 Total dimensions: 45,5x165 cm (Ø x H)



ZUIVER-CODE	GTIN-CODE	ITEM NAME		
5300047	8718548019768	PENDANT LAMP BATCHED COPPER		
PACKING	1 PCS/CTN			
QTY	CTN SIZE (CM)	CBM	NW (KG)	GW (KG)
1	49x49x22	0,05	1,6	2,7

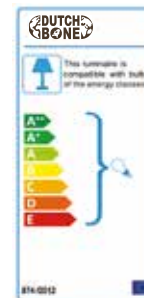



Rif floor lamp

Rif is a classic and stylish three legged floor lamp. Rif is a beautiful combination of just the right details and good proportions. The perfectly balanced, fabric, lampshade is supported by three sturdy dark wooden legs. We have cleverly hidden the power cord in one of the three legs for an uninterrupted design. The shade softens the light just enough to create a warm and yet functional lighting.

- Conical cotton shade
- Solid rubberwood tripod base in walnut colour finish
- Black PVC cable with foot on/off switch
- Light source: E27, max. 32 watt CFL
- Wire length: 196 cm
- Dimensions shade: 40/50x35 cm (Ø x H)
- Dimensions base: 50x115,6 cm (Ø x H)
- Total dimensions: 50x154 cm (Ø x H)

ZUIVER-CODE	GTIN-CODE	ITEM NAME		
5100041	8718548022089	FLOOR LAMP RIF		
PACKING	1 PCS/CTN			
QTY	CTN SIZE (CM)	CBM	NW (KG)	GW (KG)
1	120x54x15,5	0,1	4,5	7,6

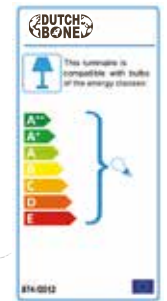



Woodland floor lamp

When one travels around the world, shopping for inspiration for new materials, styles and products, ideas for unconventional combinations can suddenly pop up. Our design team decided to combine light and wood veneer. Ash wood turned out to give the best results in bending and emitted light colour. We gave floor lamp Woodland a graceful, slender yet sturdy tripod base made of black steel. Floor lamp Woodland also comes in a table lamp version.

- Ash wood veneered shade
- Black lacquered iron tripod base
- Black PVC cable with foot on/off switch
- Light source: E27, max. 13 watt CFL
- Wire length: 200 cm
- Dimensions shade: 45x25 cm (Ø x H)
- Dimensions base: 50x130 cm (Ø x H)
- Total dimensions: 50x150 cm (Ø x H)

ZUIVER-CODE	GTIN-CODE	ITEM NAME			
5100032	8718548019836	FLOOR LAMP WOODLAND			
PACKING	1 PCS/CTN				
QTY	CTN SIZE (CM)	CBM	NW (KG)	GW (KG)	
1	47x47x30	0,07	1,8	3,8	

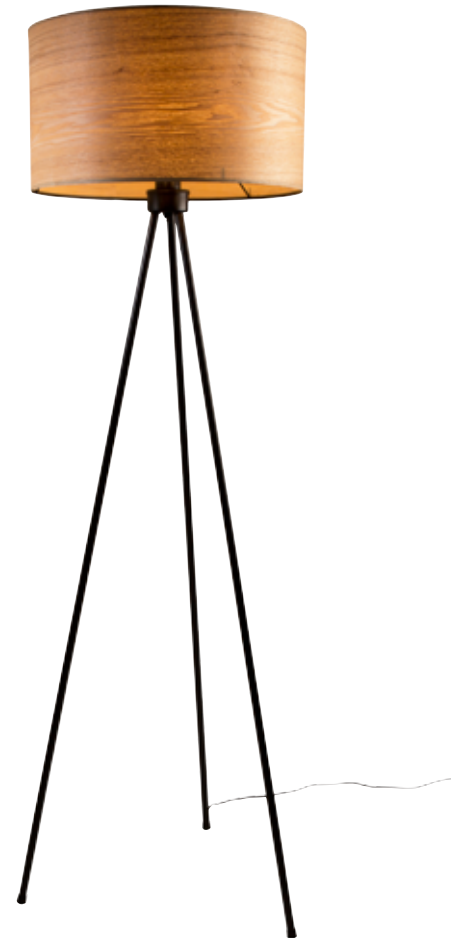

Woodland table lamp

When one travels around the world, shopping for inspiration for new materials, styles and products, ideas for unconventional combinations can suddenly pop up. Our design team decided to combine light and wood veneer. Ash wood turned out to give the best results in bending and emitted light colour. We gave table lamp Woodland a graceful, slender yet sturdy tripod base made of black steel. Table lamp Woodland also comes in a floor lamp version.

Ash wood veneered shade
 Black lacquered iron tripod base
 Black PVC cable with on/off switch
 Light source: E27, max. 13 watt CFL
 Wire length: 150 cm
 Dimensions shade: 30x25 cm (Ø x H)
 Dimensions base: 17x40 cm (Ø x H)
 Total dimensions: 30x60 cm (Ø x H)



ZUIVER-CODE	GTIN-CODE	ITEM NAME		
5200011	8718548019829	TABLE LAMP WOODLAND		
PACKING	1 PCS/CTN			
QTY	CTN SIZE (CM)	CBM	NW (KG)	GW (KG)
1	33x33x30	0,03	1	1,8

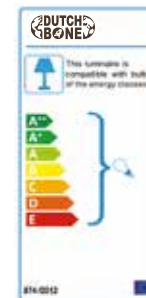

**DEAL WITH DECORATION.
IT IS THE FINISHING TOUCH.**





Scarflower stool

In a village east of Delhi, India, we found craftsmen who are very skilled in patterning metal. Our Scarflower stool, slash side table, is decorated with a beautifully handcrafted flower pattern, hammered into it. Scarflower comes in a set of two.

Set of 2 stools

Hand embossed sheets of metal welded together

Copper antique finish

Dimensions small: 32x39 cm (Ø x H)

Dimensions large: 40x54 cm (Ø x H)



ZUIVER-CODE	GTIN-CODE	ITEM NAME		
2400004	8718548020092	STOOL SCARFLOWER SET		
PACKING	1 PCS/CTN (SET OF 2)			
QTY	CTN SIZE (CM)	CBM	NW (KG)	GW (KG)
1 (SET OF 2)	51x51x56	0,146	9,5 (6+3,5)	13



Warung stool

In a village east of Delhi, India, we found craftsmen who are very skilled in patterning metal. Side table Warung is made out of skilfully hammered metal. Because of its size and sturdiness Warung can double as a stool.

Hand embossed aluminium shapes welded together
Copper colour finish
Dimensions: 31,5x47 cm (Ø x H)



ZUIVER-CODE	GTIN-CODE	ITEM NAME		
2400005	8718548020108	STOOL WARUNG		
PACKING	1 PCS/CTN			
QTY	CTN SIZE (CM)	CBM	NW (KG)	GW (KG)
1	35x35x51	0,062	2,5	4,5



Indian Block stool

This Indian Block stool is able to transform the duller lounge area into something special. Especially when you realize the fabric was not simply screen printed but stamped by hand. Originally block printed fabric was mainly used for menswear, but also for home furnishing. Nowadays screen prints took over the majority of the menswear market. Luckily the craft survived. One could say it makes more sense to use the block printing craftsmanship for furniture; On fabrics that generally last much longer than a garment. Our Indian Block stool comes in two colours; A vibrant yellow and a distinguished grey, matching colours that go very well with our other block printed items.

100% cotton, block printed by hand
 Filling: PU-foam
 Solid sheesham wooden legs
 Dimensions: 40x40x35 cm (WxDxH)



ZUIVER-CODE	GTIN-CODE	ITEM NAME		
3300018	8718548019935	STOOL INDIAN BLOCK YELLOW		
3300019	8718548019942	STOOL INDIAN BLOCK GREY		
PACKING	1 PCS/CTN			
QTY	CTN SIZE (CM)	CBM	NW (KG)	GW (KG)
1	42x42x37	0,065	4,6	5,6



Indian Block pouf

Our pouf Indian Block is composed out of beautifully hand stamped, block printed fabric. Imagine that every colour of the print in this beautiful pouf requires another wooden stamp with a precise interlocking design. Not only the carving of these blocks requires real craftsmanship, also the stamping itself is a difficult metier. Our Indian Block pouf comes in two colours; A vibrant yellow and a distinguished grey, matching colours for our other block printed items.

100% cotton, block printed by hand
 Filling: 100% recycled cotton
 Dimensions: 40x40x40 cm (WxDxH)



ZUIVER-CODE	GTIN-CODE	ITEM NAME			
3300020	8718548019959	POUF INDIAN BLOCK YELLOW			
3300021	8718548019966	POUF INDIAN BLOCK GREY			
PACKING	1 PCS/CTN				
QTY	CTN SIZE (CM)	CBM	NW (KG)	GW (KG)	
1	42x42x42	0,074	8,5	9,5	



Indian Block pillow

When choosing a pattern for our block printed pillow we weren't picky. We loved them all. Little did we know that block printed fabric in clothes can reveal a lot about its owner. Patterns, colours and the way the cloth is wrapped around ones body, can indicate caste, occupation, regional origin and religion. We checked: the prints on our Indian Block pillow are purely decorative and simply beautiful. Our Indian Block pillow comes in two sizes and colours; a vibrant yellow and a distinguished grey, matching colours that go very well with our other block printed items.

100% cotton, block printed by hand
 Filling: 100% polyester fibre
 Dimensions: 50x50 cm or 70x70 cm (LxW)



ZUIVER-CODE	GTIN-CODE	ITEM NAME		
8600008	8718548019898	PILLOW INDIAN BLOCK '50 YELLOW		
8600009	8718548019904	PILLOW INDIAN BLOCK '50 GREY		
8600010	8718548019911	PILLOW INDIAN BLOCK '70 YELLOW		
8600011	8718548019928	PILLOW INDIAN BLOCK '70 GREY		
PACKING	5 PCS/CTN	ORDER QTY: 5 PCS		
SIZE	CTN SIZE (CM)	CBM	NW (KG)	GW (KG)
5x '50	52x52x18	0,049	5	6
5x '70	72x72x20	0,104	10	11,25



Velvet pillow

For pillow Velvet we shopped at Asian markets to find the right fabric and colour combinations. Velvet turned out to measure up to the look and feel we were searching for. Pillow Velvet is of course available in a regular square shape. For your convenience we added a rectangular one, for a comfortable, lower back support.

100% velvet-look polyester, colour fastness 3-4

Filling: 100% polyester fibre

Dimensions square: 45x45 cm (LxW)

Dimensions rectangular: 60x30 cm (LxW)



ZUIVER-CODE	GTIN-CODE	ITEM NAME		
8600012	8718548021273	PILLOW VELVET SQUARE CHAMPAGNE		
8600013	8718548021297	PILLOW VELVET SQUARE WINE		
8600014	8718548021310	PILLOW VELVET RECTANGLE CHAMPAGNE		
8600015	8718548021334	PILLOW VELVET RECTANGLE WINE		
PACKING	6 PCS/CTN	ORDER QTY: 6 PCS		
SIZE	CTN SIZE (CM)	CBM	NW (KG)	GW (KG)
6x SQUARE	21,5x67x43	0,062	4,8 (6x0,8)	5,5
6x RECTANGLE	28x67x27	0,051	3,9 (6x0,65)	4,5



Ottava pillow

Pillow Ottava comes from a European pillow wizard we found during our travels to a local fair. We took our time to decide on the colour combinations. We found these particular colour combinations match best with a Dutchbone interior.

74% viscose, 21% PES, 5% cotton; colour fastness 4-5
 25.000 Martindale
 Filling: 100% polyether
 Dimensions: 45x45 cm (LxW)



ZUIVER-CODE	GTIN-CODE	ITEM NAME			
8600016	8718548022034	PILLOW OTTAVA GREEN/BLUE			
8600017	8718548022058	PILLOW OTTAVA RED/ORANGE			
PACKING	6 PCS/CTN	ORDER QTY: 6 PCS			
QTY	CTN SIZE (CM)	CBM	NW (KG)	GW (KG)	
6	50x50x50	0,125	4,2 (6x0,7)	5,5	



Shaun sheepskin

In large parts of the world furniture is made more comfortable with sheepskin. Not only are they warm, soft and pillow-like, they are also stylish. Our Shaun sheepskins come from genuine Down Under Merino sheep. One of the world's most ancient breeds. Their wool is fit for extremes; breathable in summer, insulating in winter, but always exceptionally soft and light-weight. Shaun comes in the usual colour white, but also in different versions. Since we added coloured sheepskins like Pinot Red, Caspian Green and Chocolate. They match wonderfully with our Kubu chairs!

100% wool; sheepskin from New Zealand & Australia, carefully selected half-breeds
 Colour fastness 4-5
 Dimensions: 90-94x50x5 cm (LxWxH)

Note: Mix set = 4x ivory, 2x each other colour



ZUIVER-CODE	GTIN-CODE	ITEM NAME		
8900009	8718548020405	SHEEPSKIN SHAUN IVORY		
8900010	8718548020412	SHEEPSKIN SHAUN CHOCOLATE		
8900011	8718548020429	SHEEPSKIN SHAUN PINOT RED		
8900012	8718548020436	SHEEPSKIN SHAUN CASPIAN GREEN		
PACKING	10 PCS/CTN	ORDER QTY: 10 PCS		
QTY	CTN SIZE (CM)	CBM	NW (KG)	GW (KG)
10	90x55x20	0,1	9 (10x0,9)	12

ZUIVER-CODE	GTIN-CODE	ITEM NAME		
8900013	8718548020573	SHEEPSKIN SHAUN MIX SET 10		
PACKING	1 PCS/CTN	ORDER QTY: 1 PCS (SET OF 10)		
QTY	CTN SIZE (CM)	CBM	NW (KG)	GW (KG)
1 (SET OF 10)	90x55x20	0,1	9 (10x0,9)	12



Kubu mirror

The beauty of rattan is not only in its natural colour, feel and looks, it is also in its characteristics. It grows for instance, in otherwise barren swamp areas and at an alarming rate of about 40 meters every year. We kept it uncoloured, and therefore not only at its prettiest but also at its environmental friendliest. We choose to work with the slightly thicker Kubu rattan for more style.

Our Mirror Kubu is handwoven from rattan. Unlike bamboo, rattan stems are solid and therefore easy to bend. Mirror Kubu's randomly shaped frame gives this mirror its nonchalant look while the Kubu rattan itself adds class.

Glass mirror with Kubu rattan border and plywood back
Dimensions: 75x3,2 cm (Ø x H)



ZUIVER-CODE	GTIN-CODE	ITEM NAME		
8100007	8718548020863	MIRROR KUBU		
PACKING	1 PCS/CTN			
QTY	CTN SIZE (CM)	CBM	NW (KG)	GW (KG)
1	78x78x6	0,037	2,9	4,9



Attractif mirror

This round mirror is captured in a metal frame and for a touch of style and elegance, bound together with an industrial bolt. Mirror Attractif comes in two generous sizes and in a distinguished, industrial blue colour.

Glass mirror with powder coated aluminium frame
Dimensions '16: 41x53x4 cm (WxDxH) - mirror Ø 40 cm
Dimensions '24: 60x72x4 cm (WxDxH) - mirror Ø 58 cm



ZUIVER-CODE	GTIN-CODE	ITEM NAME		
8100005	8718548020726	MIRROR ATTRACTIF '16		
8100006	8718548020733	MIRROR ATTRACTIF '24		
PACKING	1 PCS/CTN			
SIZE	CTN SIZE (CM)	CBM	NW (KG)	GW (KG)
16'	52x52x8	0,022	3,6	5,1
24'	71x71x8	0,04	7	9

Tout est possible artwork

In France we came across a workshop specialized in printing on concrete. We were intrigued. Graffiti for the home... Years before one of us photographed a quote, spray-painted on a wall in a Parisian alley. The two were soon combined in this concrete decoration. And so we once again discovered: 'tout est possible'!

Concrete decoration with printed artwork
Dimensions: 50x70x4 cm (WxHxD)



ZUIVER-CODE	GTIN-CODE	ITEM NAME		
8900014	8718548022072	ARTWORK TOUT EST POSSIBLE CONCRETE		
PACKING	1 PCS/CTN			
QTY	CTN SIZE (CM)	CBM	NW (KG)	GW (KG)
1	75x55x8	0,033	9,9	15,2



**EXPLORE MORE:
WWW.DUTCHBONE.COM**

OFFICE/SHOWROOM: Rak 20 📍 1551 NA 📍 Westzaan 📍 Holland 📍 PHONE: +31(0)75 6146020 📍 MAIL: info@dutchbone.com